

XPS-DRVP1

*Driver Board for XPS Controller and
Piezoelectric Stages*

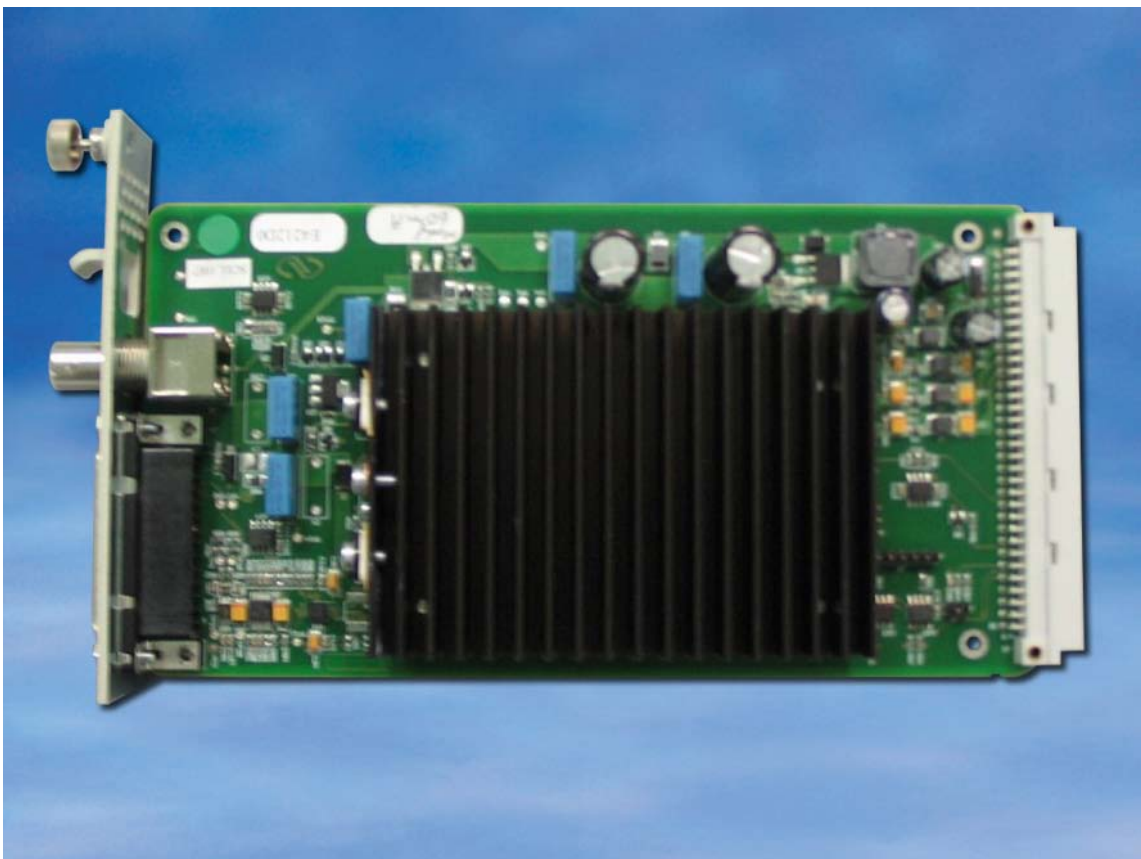

Newport®

Experience | Solutions

User's Manual

Warranty

Newport Corporation warrants this product to be free from defects in material and workmanship for a period of 1 year from the date of shipment. If found to be defective during the warranty period, the product will either be repaired or replaced at Newport's discretion.

To exercise this warranty, write or call your local Newport representative, or contact Newport headquarters in Irvine, California. You will be given prompt assistance and return instructions. Send the instrument, transportation prepaid, to the indicated service facility. Repairs will be made and the instrument returned, transportation prepaid. Repaired products are warranted for the balance of the original warranty period, or at least 90 days.

Limitation of Warranty

This warranty does not apply to defects resulting from modification or misuse of any product or part.

CAUTION

Warranty does not apply to damages resulting from:

1. Incorrect usage:

- **With a non-Newport XPS controller.**
- **Improper connection and grounding.**
 - **Connectors must be properly secured.**
 - **Use of extension cables without Newport agreement.**
 - **When the load on the stage presents an electrical risk, it must be connected to ground.**

2. Modification of the board or any part therein.

THIS WARRANTY IS IN LIEU OF ALL OTHER WARRANTIES, EXPRESSED OR IMPLIED, INCLUDING ANY IMPLIED WARRANTY OF MERCHANTABILITY OR FITNESS FOR A PARTICULAR USE. NEWPORT CORPORATION SHALL NOT BE LIABLE FOR ANY INDIRECT, SPECIAL, OR CONSEQUENTIAL DAMAGES.

First printing 2010

Copyright 2010 by Newport Corporation, Irvine, CA. All rights reserved. No part of this manual may be reproduced or copied without the prior written approval of Newport Corporation. This manual is provided for information only, and product specifications are subject to change without notice. Any change will be reflected in future printings.

Table of Contents

Warranty	ii
Definitions and Symbols	iv
Warning	v
Cautions	vii
<hr/>	
1.0 Introduction.....	1
<hr/>	
2.0 Overview of piezoelectric technology	2
2.1 Actuator principle	2
2.2 Actuator travel range	2
2.3 Stages principle	Erreur ! Signet non défini.
2.4 Position sensors	3
2.5 Piezoelectric technology pros and cons	4
<hr/>	
3.0 Newport solution advantages	4
3.1 Control loops	4
3.1.1 Open loop	5
3.1.2 Close loop control	6
<hr/>	
4.0 Specifications.....	8
4.1 XPS-DRVP1 Functional description	8
4.2 XPS-DRVP1 Specifications	8
<hr/>	
5.0 Starting up.....	9
5.1 Installing the XPS-DRVP1 in the XPS controller	9
5.2 Stage connection	9
5.3 Powering up.....	10
5.3.1 XPS Controller	10
5.3.2 Axis initialization	10
5.3.3 Axial Load verification	11
<hr/>	
6.0 Offset adjustment procedure	13
<hr/>	
7.0 Accuracy linear correction procedure.....	15
<hr/>	
8.0 Description/Use of « BNC » output.....	17

9.0	Specific APIs.....	18
<hr/>		
10.0	Parameters description	18
10.1	« System.ini» File	18
10.2	« Stages.ini» File	19
<hr/>		
11.0	Maintenance	20
11.1	Axis initialization after error	20
11.2	Maintenance	21
11.3	Repair	21
<hr/>		
	Service Form	23

Definitions and Symbols

The following terms and symbols are used in this documentation and also appear on the product where safety-related issues occur.

General Warning or Caution



The exclamation symbol may appear in warning and caution tables in this document. This symbol designates an area where personal injury or damage to the equipment is possible.

European Union CE Mark



The presence of the CE Mark on Newport Corporation equipment means that it has been designed, tested and certified as complying with all applicable European Union (CE) regulations and recommendations.



ATTENTION

This board is designed to be used ONLY inside a Newport XPS controller. Proper installation procedure must be followed to ensure CE Mark compliance.

Warnings and Cautions

The following are definitions of the Warnings, Cautions and Notes that may be used in this manual to call attention to important information regarding personal safety, safety and preservation of the equipment, or important tips.



WARNING

Situation has the potential to cause bodily harm or death.



CAUTION

Situation has the potential to cause damage to property or equipment.

NOTE

Additional information the user or operator should consider.

Warning



WARNING

Do not attempt to modify this board; this may cause an electric shock or downgrade its performance.



WARNING

This product, like all microcontroller products, uses semiconductors that can be damaged by electrostatic discharge (ESD). When handling, care must be taken so that the devices are not damaged. Damage due to inappropriate handling is not covered by the warranty.

Cautions



CAUTION

As Newport piezoelectric stages might include flexure mechanisms with limited load capacity, do not move the moving part of the stage manually.

CAUTION

Do not disconnect the stage cable when the XPS controller is powered ON.

XPS-DRVP1

1.0 Introduction

This manual describes the operating instructions for the XPS-DRVP1 driver board.



XPS-DRVP1 Driver board.

Newport « XPS-DRVP1 » driver board has been specially designed to provide POWERFUL and SIMPLE CONTROL, through XPS controller, of Newport stages motorized by piezoelectric actuators from the following series:

NPA, NPM, NPO, NPX, NPXY, NPXY and PSM.

RECOMMENDATION

You must read the chapter 5 “[Installing the XPS-DRVP1 in the XPS controller](#)” carefully before attempting to use the XPS-DRVP1 driver board.

2.0 Overview of piezoelectric technology

2.1 Actuator principle

A piezoelectric actuator is made of crystals (PZT: Plumbium Zirconate Titanate) having three properties:

- It expands whenever a voltage is applied at the ends.

The crystal expands linearly to the voltage applied, which can be up to ~100V:

$$L = K_E * V \text{ (} K_E = \text{crystal expansion coefficient in } \mu\text{m/V).}$$

- It shrinks whenever a force is applied on it.

The compression of the crystal also follows a linear law depending on the applied force:

$$L = F / K_C \text{ (} K_C = \text{crystal stiffness in N/}\mu\text{m represented by the springing the figure beside).}$$

- It has hysteresis (H)

Under the same conditions of input voltage and force applied, an actuator does not go back to the exact same size.

Consequently, the length of the crystal depends on the voltage and on the force applied.

This expansion being relatively small ($L = \sim 0.1\% L$), several crystals can be stacked and wired in parallel to obtain longer travel ranges.

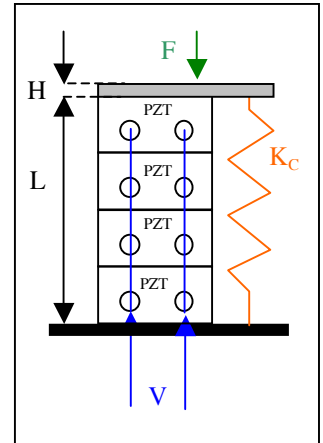

Note: The piezoelectric principle is reversible, by applying a force to this crystal; it creates a voltage difference between the ends.

2.2 Actuator travel range

Without being powered, and without any force applied, a piezoelectric actuator rests in an equilibrium region called **Origin zone**.

When applying the maximum voltage, the actuator reaches its maximum expansion called the **Actuator Range**

Without being powered and applying the maximum force permissible, the actuator reaches its maximum compression called the **Actuator Compression**

The sum of actuator range and actuator compression is called the **Physical Range**

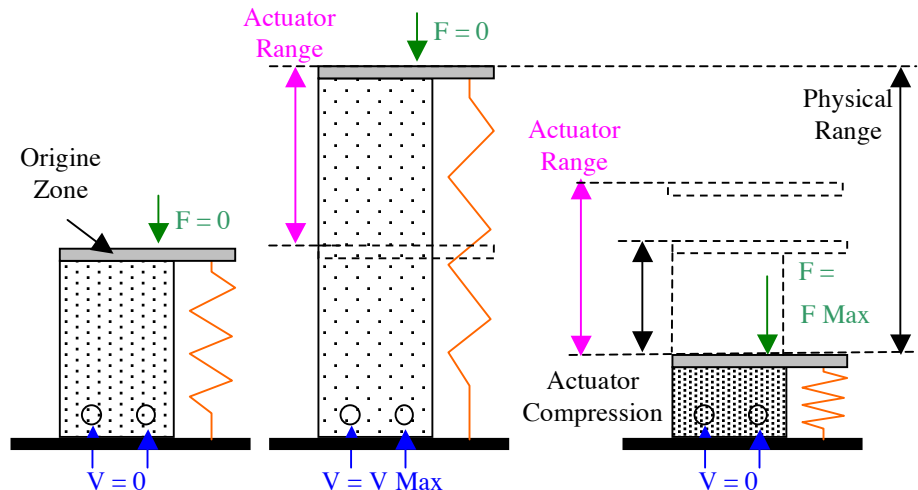

2.3 Piezoelectric Stages

Two types of stages use piezoelectric actuators:

- **Direct:** No mechanism is added, the crystal directly « pushes » the moving part (i.e. : actuator)

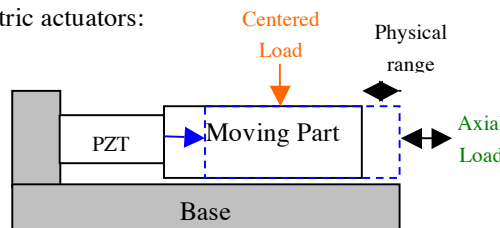

- **Amplified:** the crystal pushes the mobile part decoupled from the base by flexures. The motion can be amplified by lever arms shown below (i.e. : NPX stages)

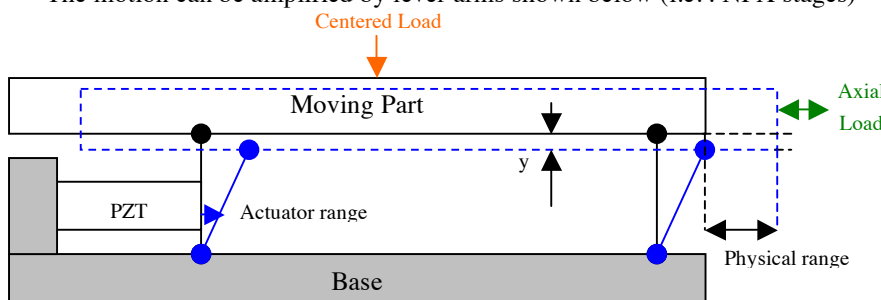

Note: The design of the stage mechanism is important to minimize the motion in the orthogonal dimension (y) which can be neglected.

2.4 Position sensors

Stages can be equipped with position sensors of the “strain gauge” type which is made of thin metallic conductors (few μm thick) placed on a non-conductive material.

Expansion of the conductors changes electrical resistance following a linear law:

$$\frac{\Delta R}{R} = K_j * \frac{\Delta L}{L}$$

The relative displacement measured at the strain gauge is directly proportional to the stage mobile part displacement and so provides position information.

The sensor’s range is greater than the full physical range of the stage.

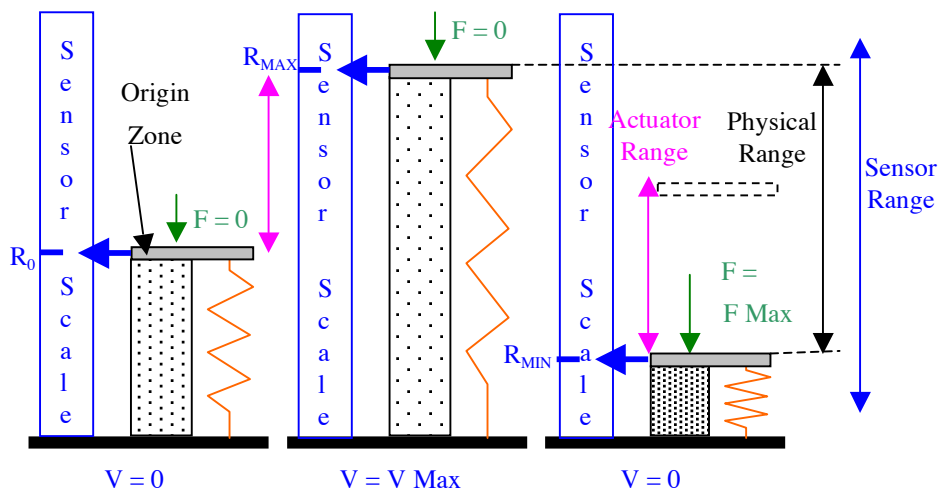
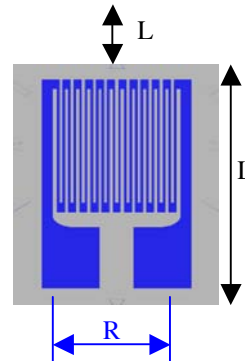

2.5 Piezoelectric technology pros and cons

Stages using piezoelectric technology usually have a relatively **small footprint** and offer **high sensitivity** (nanometer level) combined with **fast motion** (frequency of several hundreds Hertz for actuators).

Position can be controlled simply in **open loop** by providing a voltage to the actuator (~0 to 100V), but **hysteresis** can reach up to 10% of the range.

“**Direct**” type of stages offers a **short range** (few hundred microns) with **high axial load capacity** (several tens of kilograms) and good axial stiffness (several tens of N/ μ m)

“**Amplified**” type of stages offers longer range but drastically reduced axial load capacity (kilogram level) and axial stiffness (N/ μ m level).

Stages equipped with **position sensors** allow **hysteresis compensation** but **requires close loop control** mode.

Higher **absolute accuracy** can be obtained but requires **stage calibration** using an external device.

3.0 Newport solution advantages

Newport piezoelectric actuators and stages controlled through the XPS controller and the XPS-DRVP1 driver board **provide simple efficient solutions** for a wide variety of applications from **fast positioning** with **high resolution** to **fast signal tracking** and to **true high resolution/accuracy absolute positioning**.

All Newport piezoelectric stages are tested and calibrated in the factory. Calibration parameters like: piezoelectric actuator input voltage range, stage range, sensor (if present) position and resolution, etc. are **loaded into the stage’s EEPROM**.

During initialization, the XPS controller and the XPS-DRVP1 driver boards read these parameters and **automatically configure the axis for optimum control** (open / close loop, resolution, range, etc.)

The **stage can then be used like any motorized stage** with origin position, software limits, relative and absolute moves, etc.

XPS-DRVP1 driver board also features a **position sensor feedback analog signal output** providing precise stage real position information. See chapter: [« BNC » output](#)

Newport solution also allows **sensor calibration** to improve the stage absolute accuracy. See chapter: [Accuracy linear correction](#).

3.1 Control loops

After power-on and during initialization, the XPS controller through the XPS-DRVP1 driver board reads the parameters from the connected stage and sets the corresponding control loop type:

- Without sensor (i.e. NPX400-D, NPXY200-D, etc.) : **Open loop** control
- With sensor (i.e. NPX400SG-D, NPXY200SG-D, etc.) : **Close loop** control

3.1.1 Open loop

In the case of stages without sensors, an open loop control is used and the XPS-DRVPI board generates a voltage to control the actuator proportional to the theoretical desired position.

Operators can use the XPS control range set from **0 to Actuator range**.

The actuator moves between positions:

“rest position” ($V=0$) and

“rest position + actuator range” ($=V_{Max}$).

However, the stage’s actual position will be affected by the intrinsic hysteresis shown in Figure 1.

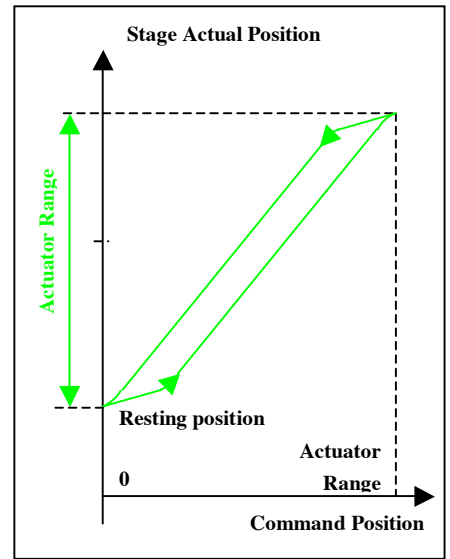

Figure 1 : Open loop, without axial load

If an axial load is initially applied to the stage, the actuator shrinks (or expands accordingly).

The actuator rest position is shifted (up or down).

The operator still issues a command via the XPS to a position between **0 and the Actuator range**.

The actuator moves between positions:

“New rest position” ($V=0$) and

“New rest position + actuator range”

($V=V_{Max}$), (Figure 2).

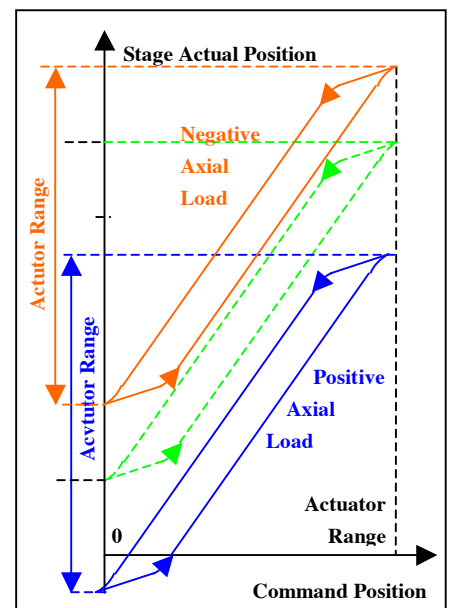

Figure 2 : Open loop, with axial load



WARNING

DO NOT OVERLOAD THE STAGE. If the axial load exceeds the maximal permissible load of the actuator, the available travel range will be reduced and the stage might even be damaged.

3.1.2 Close loop control

For stages equipped with a strain gage sensor, the XPS controller and XPS-DRVPI board allow true absolute positioning by generating the necessary voltage to the actuator to maintain the desired absolute position based on the sensor scale.

At power-on and during initialization, the **stage usable range**, corresponding control voltage, sensor origin and current positions are read from the stage EEPROM and are used to set the necessary driver board closed loop parameters and also the **XPS control range** at 80% of the open loop **actuator range**.

As described in the [Actuator travel range](#) chapter, modifying the stage axial load will shift the actual stage travel range within its physical range. Three cases can be considered:

- **Without any axial load** a Newport piezoelectric stage resting position is very close to its sensor origin position and the [Default configuration](#) can be used.
- **With a small variation of the axial load** the resting position is slightly shifted causing a stage [Usable range limitation](#)
- **In the case of a high axial load**, although the actuator range is shifted along the sensor absolute scale and the usable range is reduced, the XPS controller allows [Full range recovery](#) and maintains the same origin. This is done by setting the « **DriverStagePositionOffset** » (D_{SPO}) parameter.

3.1.2.1 Default configuration

By default, the « DriverStagePositionOffset » (D_{SPO}) parameter is set to 0.

The XPS command “0” position is set to correspond to the stage origin position

The XPS control range is set to 80% of the actuator range and **software limits are placed at:**

“0” and “control range” values.

Operators can use the XPS control range set from “0” to “Control range”.

The actuator moves between positions: “Origin” and “Origin + Usable range”.

The actual position of the stage will not be affected by the hysteresis of the actuator (Figure 3).

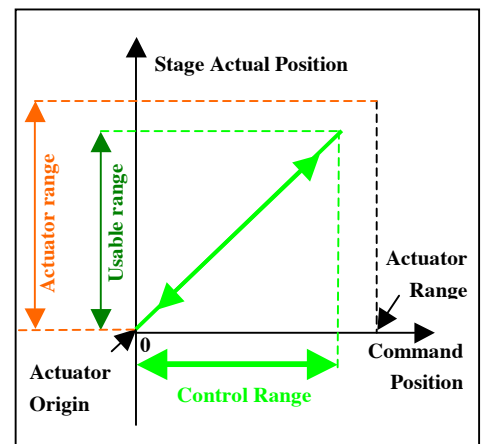

Figure 3 : Close loop default configuration

Notes: Relatively small axial load variations will not affect the actual position as the close loop control will compensate for actuator shrinking.

However, after an axial load variation, when disabling the control loop, the stage may drift to its new resting position and “jump” back to the command position when the loop is re-enabled.

A larger axial load variation may also reduce the usable range (see below)

3.1.2.2 Usable range limitation

In case of axial load variation, the piezoelectric actuator will shrink (or expand). The stage resting position is shifted along the sensor scale (i.e. to position -X). The actuator range is now from “-X” to “Actuator range-X”

The control command range remains from “0” to “Control range” (limited by software limits).

Operator can only control the stage from “0” to “Actuator range -X”. Trying to move above “actuator range -X” will generate an error.

So the usable range is limited (figure 4)

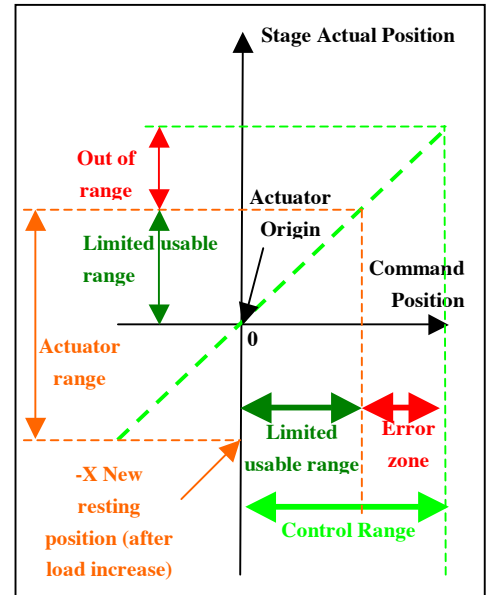

Figure 4 : Close loop with limited range

Note: When disabling the control loop, the stage drifts to its new resting position and “jump” back to the command position when the loop is re-enabled.

3.1.2.3 Full range recovery

During initialization, the XPS software limits are in fact placed at “D_{SPO}” (« DriverStagePositionOffset ») and “D_{SPO} + control range” values. Giving the D_{SPO} parameter the value corresponding to the resting position under axial load allows full range recovery as described below:

Under some axial load, the stage resting position is shifted along the sensor scale (i.e. to position “-X”).

The **actuator range** is now from “-X” to “Actuator range-X”

With “D_{SPO}” set at “-X”, the control **command range** is now set from “-X” to “Control range -X” (software limits).

Operators can control the stage on its full **usable range** again from “-X” to “Control range -X”

The XPS “0” position still corresponds to the same stage physical origin position. (Figure 5)

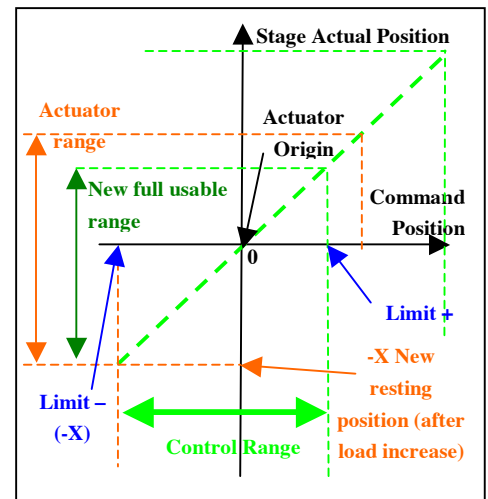

Figure 5 : Close loop after full range recovery

To modify D_{SPO} parameter, refer to the chapter: [Offset adjustment procedure](#)



WARNING

DO NOT OVERLOAD THE STAGE. If the axial load exceeds the maximal permissible load of the actuator, the available travel range will be reduced and the stage might even be damaged.

4.0 Specifications

4.1 XPS-DRVP1 Compatibility and Functional description

Newport « XPS-DRVP1 » driver board has been specially designed to drive the following Newport piezoelectric actuators and stages:

Stage Series	Without Position Sensor	With Position Sensor
NPA	NPA25, NPA25V6	NPA25SG, NPA25SGV6
	NPA50, NPA50V6	NPA50SG, NPA50SGV6
	NPA100, NPA 00V6	NPA100SG, NPA100SGV6
NPC	NPC3	NPC3SG
NPM	NPM140	NPM140SG
	NPM180	NPM180SG
NPO	NPO100	NPO100SG
	NPO140	NPO140SG
	NPO250, NPO250V6	NPO250SG, NPO250SGV6
NPX	NPX200, NPX200V6	NPX200SG, NPX200SGV6
	NPX400	NPX400SG
NPXY	NPXY100, NPXY100V6	NPXY100SG, NPXY100SGV6
	NPXY200	NPXY200SG
NPXYZ	NPXYZ100, NPXYZ100V6	NPXYZ100SG, NPXYZ100SGV6
PSM	PSM2	PSM2SG

Figure 6 : XPS-DRVP1 compatibility list

After installation in the XPS controller, the XPS-DRVP1 board allows:

- Automatic reading of stages parameters (stored during final testing in the factory)
- Automatic setting of control loop type (open or closed loop)
- Ensuring absolute positioning of the stage under different axial loads due to its [Range shifting](#) function
- Providing voltage information relative to the sensor position (if present in the stage) through « [BNC](#) » connector

4.2 XPS-DRVP1 Specifications

Parameters	Specifications
Output Voltage	-10V, + 130 V
Resolution	< 10 mV
Max. Output Current	60mA
BNC Output voltage	0 – 10V
Internal Frequency	2 kHz

Figure 7 : XPS-DRVP1 Specifications

5.0 Starting up

5.1 Installing the XPS-DRVP1 in the XPS controller



WARNING

Do not open the protective conductive packaging until you have read the following, and are at an approved anti-static work station.

Use a conductive wrist strap attached to a good earth ground.

Always turn the controller's power OFF before installing a board.

Always discharge yourself by touching a grounded bare metal surface or approved anti-static mat before picking up an ESD - sensitive electronic component.

Use an approved anti-static mat to cover your work surface.

To install XPS-DRVP1 driver board in XPS controller, proceed as follows:

- Select an available slot and remove the corresponding plate (1 screw)
- Remove the board from its package holding it by the rear plate (avoid touching the printed circuit)
- Insert the board in the slot and tighten the blocking screw

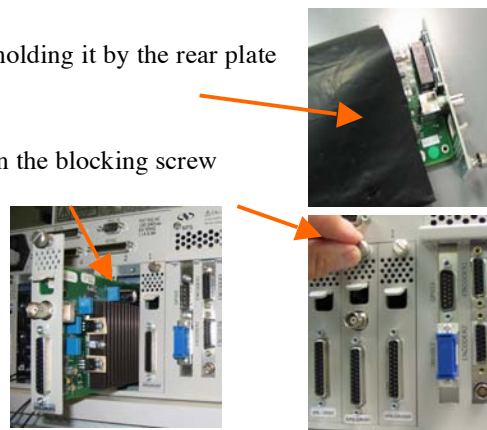

5.2 Stage connection



WARNING

Always turn the controller's power OFF before connecting to a stage.

Connect the 25-pin, male Sub-D connector to the XPS-DRVP1 driver board terminal.



WARNING

All Newport products are provided with standard cable length. The use of extension cable is not advised as it might result in the degradation of your product performance. Please contact Newport Corp. for any cable extension need.

5.3 Powering up

After installing the XPS-DRVP1 board, the XPS controller can now be powered on. However, the presence of this new board requires updating the XPS controller initialization file « system.ini ».

Then, after the correct parameter setting, the axis (driver board + stage without axial load) can be initialized.

Finally, in case of a stage equipped with position sensor, verify the behaviour of the axis depending on the axial load place on the stage.

5.3.1 XPS Controller

For instructions on how to update « system.ini » initialization file, refers to « Getting started/ configuring the controller » section of the XPS UserManual. (See also the File <<System.ini>> chapter for “system.ini” file example)

Note: If the new driver board and/or the stage are not automatically detected, the XPS firmware might need to be updated manually. Refer to chapter 6.4 «Software Tools/Maintenance and Service » of the XPS « UserManual » documentation. Latest XPS firmware package can be downloaded from Newport ftp site at:
ftp://download.newport.com/MotionControl/Current/MotionControllers/XPS/Updates/

At the end of start up procedure, the XPS controller has recognized the driver board and the stage. Example of the XPS Front panel/Move page

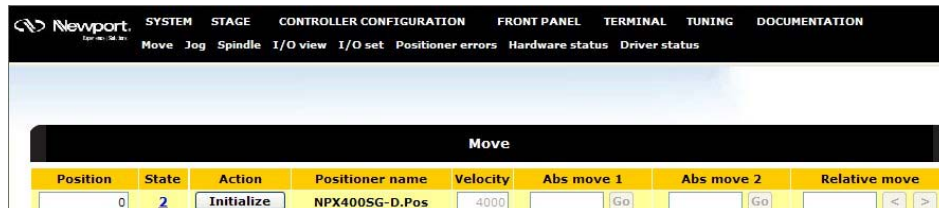

Position	State	Action	Positioner name	Velocity	Abs move 1	Abs move 2	Relative move
0	2	Initialize	NPX400SG-D.Pos	4000	Go	Go	< >

5.3.2 Axis initialization

Note: When using the stage for the first time, initialize the axis without load on the stage.

The XPS-DRVP1 driver board must be initialized to set all axis parameters (loop type, range and software limits). This can be done by clicking on « Initialize » button:

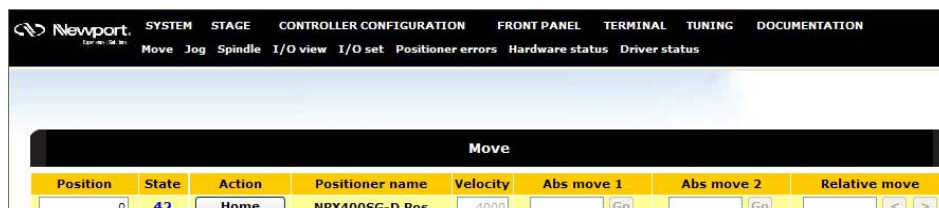

Position	State	Action	Positioner name	Velocity	Abs move 1	Abs move 2	Relative move
0	42	Home	NPX400SG-D.Pos	4000	Go	Go	< >

Note: At the end of initialization, the axis control loop is activated and so the stage might slightly move to reach the actual command position.

The axis must now be referenced by clicking on « Home » button:

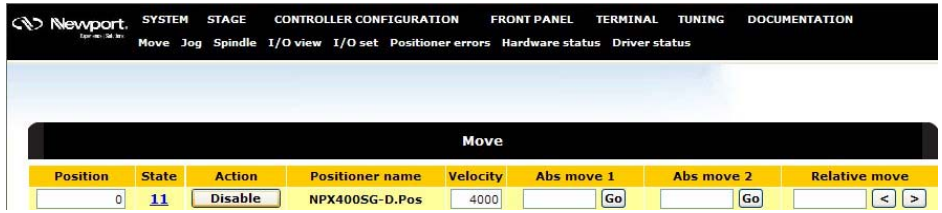

The axis is now ready to be used.

Note: A preset value can be set to the current position. See chapter: [Offset adjustment procedure](#)

5.3.3 Axial Load verification

For stages equipped with a position sensor, the following tests can be performed to verify axis behavior based on an axial load.

5.3.3.1 No axial Load

All Newport piezoelectric stages are tested and calibrated in the factory. Calibration parameters (saved in the stage’s EEPROM) allow the driver board to set the XPS controller scale Zero position at the stage origin.

With no applied power, any Newport piezoelectric stage rests in an equilibrium or rest position based on actuator’s hysteresis. Although very close, this position is always slightly different from the stage origin (within 5% of the total travel range).

The value at this rest position can be obtained using XPS Website « terminal » page.

Note: **Axis must be disabled prior to using this command**

In the list, select the command: « PositionerDriverPositionOffsetsGet » then click on « OK » and finally « Execute »



The command returns 3 numbers separated by comas:

- The first “0” indicates the correct execution of the command.
- The second number indicates the current value (in microns) of the « DriverStagePositionOffset » parameter of the « stages.ini » file. See chapter: [Offset adjustment procedure](#). (Default value: “0”)

- The third number indicates the current position (in microns) of the stage compare to the stage origin. Verify that this value is less than 5% of the stage travel range.

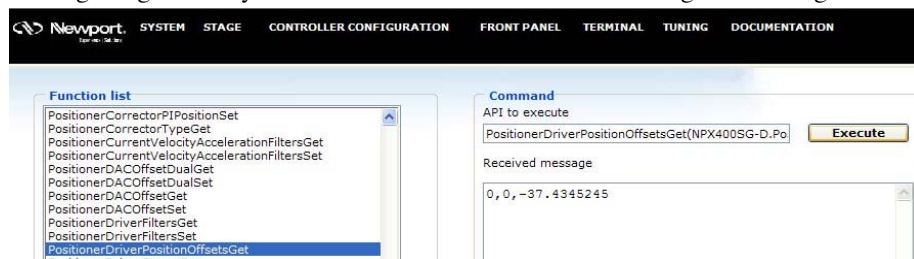

WARNING



If the resting position value of a non-energized piezoelectric stage and without any axial load is greater than $\pm 15\%$ of its total range, the stage is probably damaged. Contact Newport for service.

Note: If the axis is not disabled, the command will return an error (Error -118: Function is only allowed in DISABLE group state).

5.3.3.2 With intended axial Load

The intended axial load can now be applied. The rest position will change.

Note: Consult stage documentation to ensure intended maximal axial load is within specification.

Proceeding the same way as above, verify that the current position is less than 80% of the stage travel range.



WARNING

If the resting position value of a non-energized piezoelectric stage and with its intended axial load is greater than $\pm 80\%$ of its total range, the stage is overloaded. Using it this way might damage it !

DO NOT USE THIS CONFIGURATION.

Contact Newport for service

6.0 Offset adjustment procedure

To modify the offset parameter and therefore shift the command range, proceed as follows:

Note: Axis must be initialized prior to proceed otherwise the command will return an error (Error -117: Positioner must be initialized).

- Logon to the XPS website as an “Administrator”
- In the « Terminal » menu, select the command :
« PositionnerDriverPositionOffsetsGet »

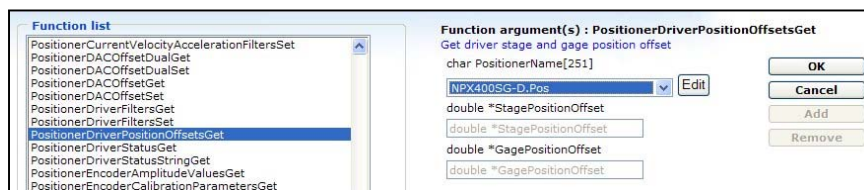

- Select the Positionner name, then click on « OK », then on « Execute »



- This command returns: “0, Offset1, Offset2” with:
 - The first “0” indicating the correct execution of the command
 - Offset1, corresponding to the parameter « DriverStagePositionOffset » current value
 - Offset2, corresponding to the stage current position
- In the list proposed by the « STAGE/Modify » menu, select the corresponding stage, and then click on « Modify » button.

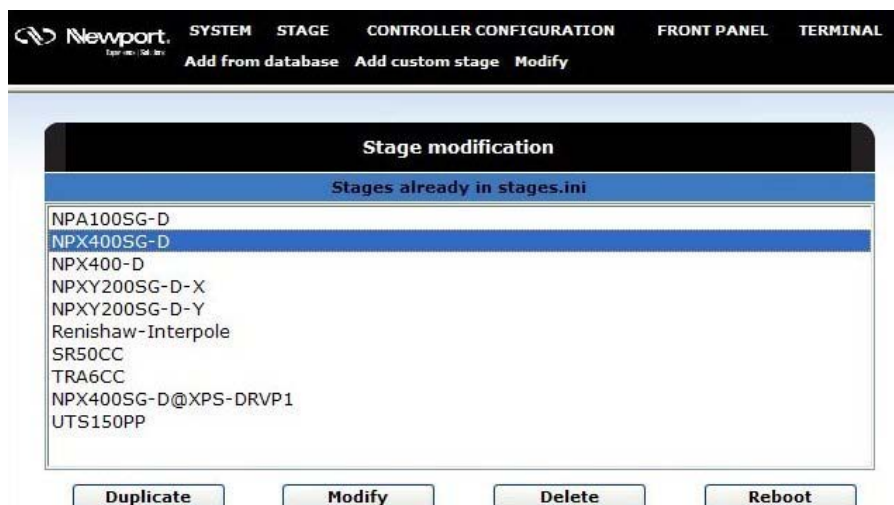

- Then, in the parameters list, find the line starting with:
« DriverStagePositionOffset »

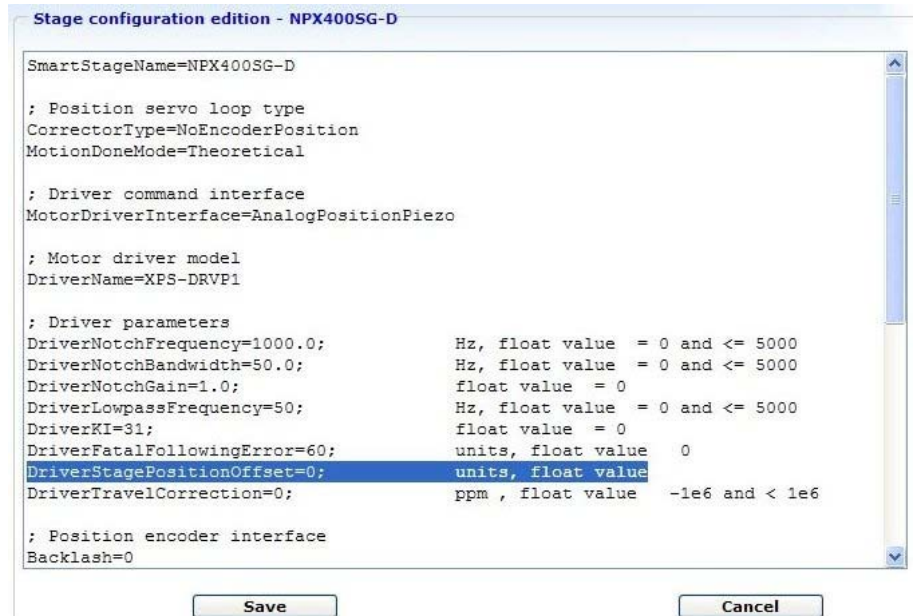

- Replace the current parameter value by « Offset2 » rounded to the next higher 10 micron increment.
- Click on « Save ». The previous page is displayed again.
- Click on « Reboot » and wait for XPS controller initialisation completion.
- Re-logout to the XPS controller « WEB » as a « User »
- In the « FrontPanel/Move » Menu, verify that the corresponding axis position is equal to Offset 2.
- Click «Initialize » and then « Home » buttons. The axis is now ready to be used between positions “Offset2” and “Offset2 + usable range”.

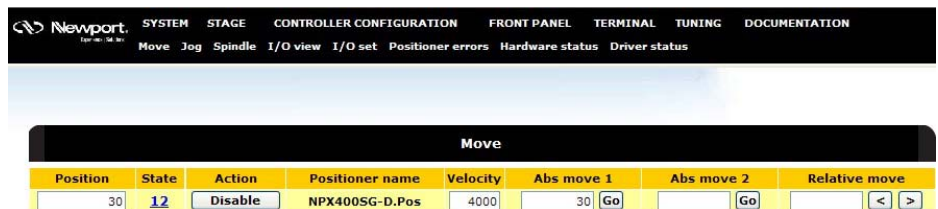

7.0 Accuracy linear correction procedure

Absolute accuracy of piezoelectric stages equipped with a position sensor and controlled in close loop is directly related to its sensor quality.

As described in the [Position sensors](#) chapter, strain gage type position sensors have a typical accuracy linearity of 0.1%.

The XPS controller and the XPS-DRVP1 driver board allow compensation for this linear error by modifying the “DriverTravelCorrection” parameter of the “Stages.ini” file.

To modify this parameter, proceed as follows:

- Install an external position measuring device (I.E. interferometer) on the moving part of the piezoelectric stage to acquire the actual stage position variation.
- In the list proposed by the « STAGE/Modify » menu, select the corresponding stage, and then click on « Modify » button.

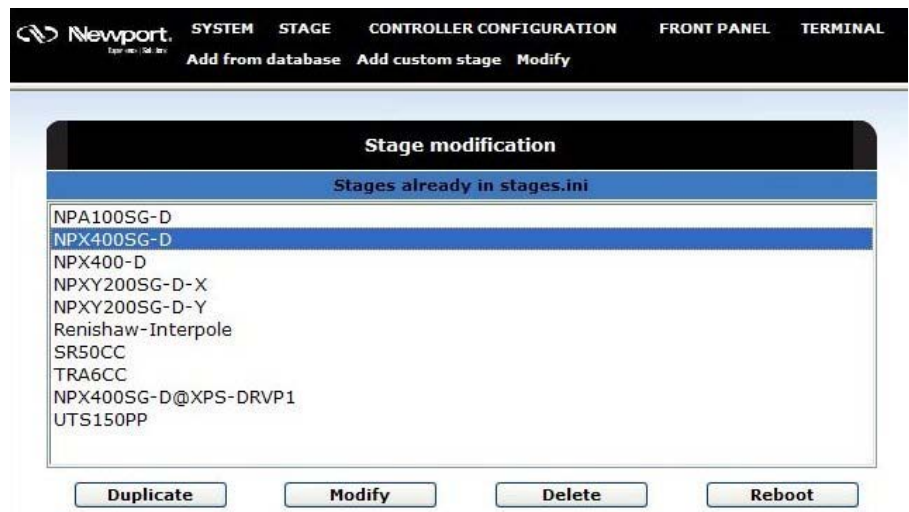

- Then, in the parameters list, find the line starting with: « DriverStagePositionOffset »

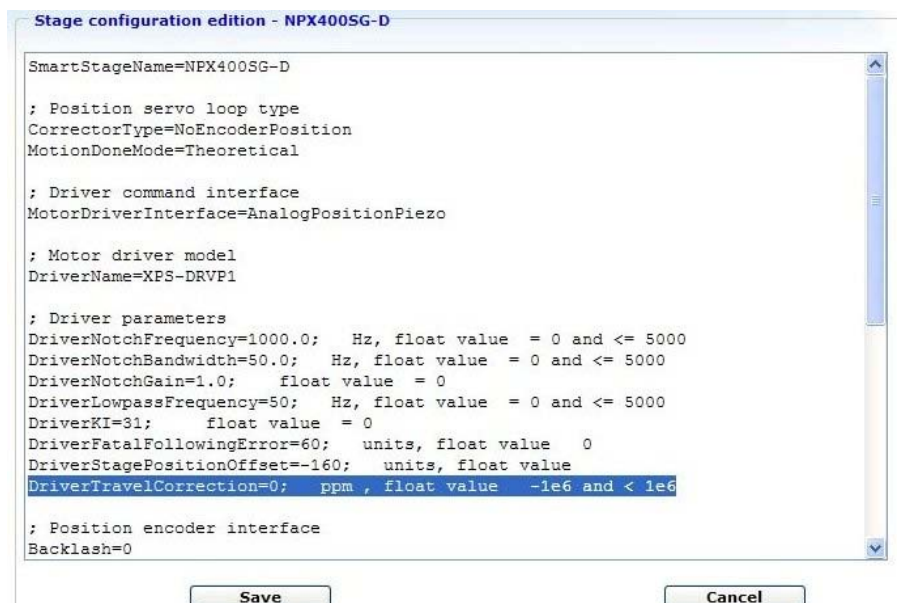

- Verify the current parameter value:
 - If it is different from 0 (default value), replace it by 0, and then click on « Modify » then « Reboot », and finally restart this procedure
 - Si it is already equal to 0, continue this procedure
- In the « FrontPanel/Move » menu :
 - Click on « initialize » then « Home » buttons of the desired axis.
 - Launch an absolute move to position “0”
- Reset to « 0 » your external sensor display.
- In the « FrontPanel/Move » menu, launch an absolute move to the stage maximum position and note this value as: C_{TH}
- Note your external sensor position value as: C_R
- Calculate the correction coefficient : $K_R=10^6*(C_{TH} - C_R)/ C_{TH}$
- Return into « STAGE/Modify » menu to display « DriverTravelCorrection » parameter value.

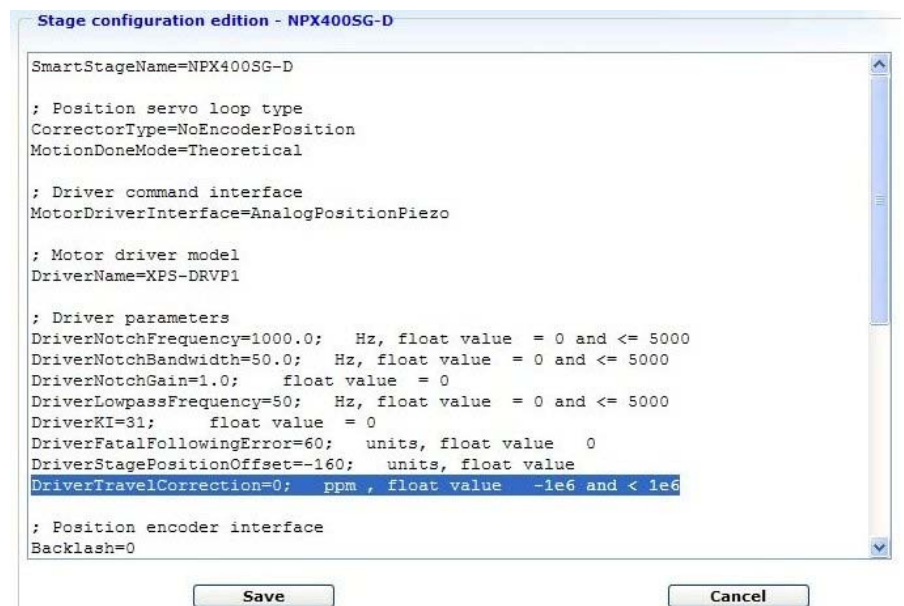

- Set the parameter « DriverTravelCorrection » value to K_R .
- Click on « Modify » and then « Reboot » buttons and wait for XPS controller initialisation completion.

The stage is now ready to be used with improved absolute accuracy.

Note: Linear compensation does not affect “BNC” voltage output

8.0 Description/Use of « BNC » output

Note: This output can be used only if the driver board controls a piezoelectric stage equipped with a position sensor.

The XPS-DRVP1 driver board features a « BNC » connector that provides an analog voltage image of the stage current position.

Output voltage ranges from 0 to 9V with:

- ~5V: when the stage is at its origin (corresponding to the sensor R_0 value).
- ~0V: when the stage is at its lower limit (not energized and maximum axial load)
- ~10V: when the stage is at its upper limit (energized at its maximum voltage and without axial load)

This output can be monitored by an oscilloscope or a multi-meter.

Accuracy of this output voltage is directly related to position sensor quality.

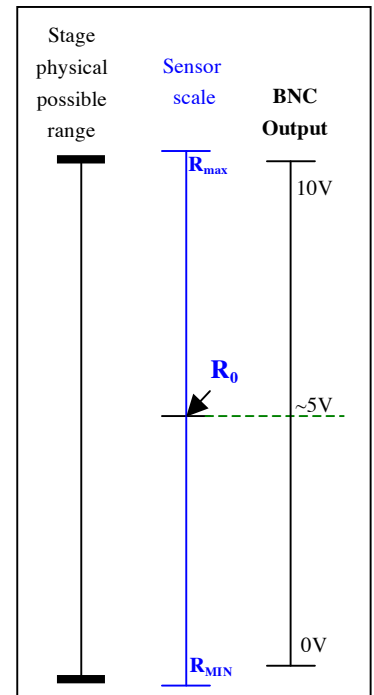

Figure 8 : BNC output during displacement

- Notes:** « BNC » output voltage does not depend on [Offset](#) nor [Linearity](#) parameter values
- « BNC » output voltage varies from one stage to another. A calibration of this voltage output can be done. To do so, proceed as follows:
- Memorize output voltage values (V_{MAX} et V_{MIN}) for stages maximal and minimal positions (P_{MAX} et P_{MIN})
 - Calculate resolution: $(V_{MAX} - V_{MIN}) / (P_{MAX} - P_{MIN})$ en $V/\mu m$



WARNING

In case of a stage placed in “disable” mode and without any axial load, if BNC output value is lower than 4 Volts or higher then 6 Volts, the stage has probably been damaged.

Contact Newport for service

9.0 Specific APIs

In addition to the standard XPS commands, the following XPS-DRVPI board specific APIs are available:

- « PositionerDriverFiltersGet » : to get axis current close loop control parameters: KI (close loop integral coefficient), Notch filter frequency, Notch filter bandwidth, Notch filter gain and Low Pass filter frequency
- « PositionerDriverFiltersSet » : to set axis closed loop control parameters
- « PositionerDriverStatusGet » : to get driver board current status number
- « PositionerDriverStatusStringGet » : to get driver board detailed status
- « PositionnerDriverPositionOffsetsGet »: to get offset parameters (see [Offset adjustment procedure](#) chapter)

10.0 Parameters description

Parameters required to drive piezoelectric stages are preset in the factory within the system.ini and stages.ini files and some of these can be modified by the user.

Examples of piezoelectric stage parameters:

10.1 « System.ini» File

Paramètre	Description / Remark
[GROUPS] SingleAxisInUse = NPX400SG-D SingleAxisThetaInUse = SpindleInUse = XYInUse = XYZInUse = MultipleAxesInUse = SingleAxisWithClampingInUse = TZInUse = InterlockedGroups=	Group definition chapter. Piezoelectric stages can be used only in the following groups : SingleAxisInUse XYInUse XYZInUse MultipleAxesInUse
[NPX400SG-D] PositionerInUse = Pos	Positioner definition chapter
[NPX400SG-D.Pos]	Positioner name. Must correspond to the name defined in the 2 previous chapters
PlugNumber = 2	Board physical address (XPS slot number)
StageName = NPX400SG-D	Name of the chapter of the « stages.ini » file containing the stage parameters.
EncoderIndexOffset = 0	General parameters. Not used by XPS-DRVPI
TimeFlasherBaseFrequency = 40e6	
MovingMass = 0	
StaticMass = 0	
Viscosity = 0	
Stiffness = 0	

Figure 9 : XPS file: « System.ini »

10.2 « Stages.ini» File

Paramètre	Description / Remarque
[NPX400SG-D]	Chapter name. Must correspond to the name defined in the « System.ini » file
SmartStageName=NPX400SG-D	Stage name. Must correspond to the name memorized in the stage EEPROM.
; Position servo loop type CorrectorType=NoEncoderPosition MotionDoneMode=Theoretical	Control loop parameters DO NOT MODIFY
; Driver command interface MotorDriverInterface=AnalogPositionPiezo	
; Motor driver model DriverName=XPS-DRVP1	Driver board name DO NOT MODIFY
; Driver parameters DriverNotchFrequency=1000.0 DriverNotchBandwidth=50.0 DriverNotchGain=1.0 DriverLowpassFrequency=50 DriverKI=31 DriverFatalFollowingError=1.0	Control loop parameters depending on the stage type. DO NOT MODIFY
DriverStagePositionOffset=0	Offset parameter. See chapter : Offset adjustment procedure
DriverTravelCorrection=0	Accuracy parameter. See chapter : Offset adjustment procedure
; Position encoder interface Backlash=0 CurrentVelocityCutOffFrequency=100 CurrentAccelerationCutOffFrequency=100 PositionerMappingFileName=	Control loop parameters DO NOT MODIFY
; Limit sensors input plug ServitudesType=Piezo MaximumVelocity=4000 MaximumAcceleration=100000 EmergencyDecelerationMultiplier=4 MinimumJerkTime=0.04 MaximumJerkTime=0.04 TrackingCutOffFrequency=25	Control loop parameters DO NOT MODIFY
; Home search process HomeSearchSequenceType=CurrentPositionAsHome HomeSearchMaximumVelocity=4 HomeSearchMaximumAcceleration=100 HomeSearchTimeOut=60	General parameters. Not used by XPS-DRVP1

Figure 10 : XPS file: « Stages.ini »

11.0 Maintenance

11.1 Axis initialization after error

In case of malfunction, the XPS-DRVPI driver board returns an error and the XPS controller will automatically “kill” the axis. XPS website allows checking the type of error(s).

Select FRONT PANEL/Driver Status to display the current XPS-DRVPI driver board

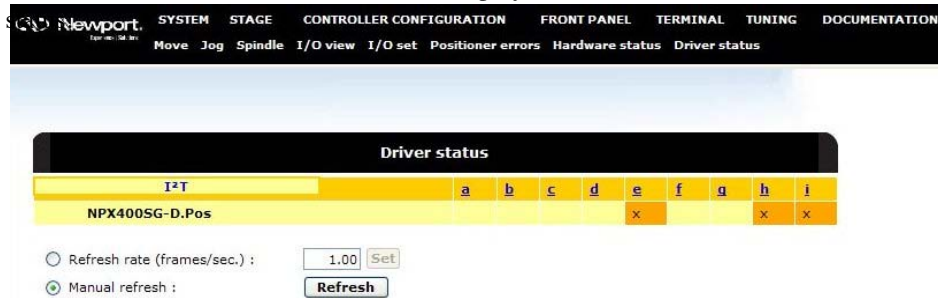

Following errors can occur on a XPS-DRVPI driver board:

- b: Broken fuse or Voltage out of range
- c: Thermistor fault
- d: Initialization error
- e: (I²T) Dynamic error or Following error
- g: Stage not connected
- h: Inhibition input
- i: Driver fault

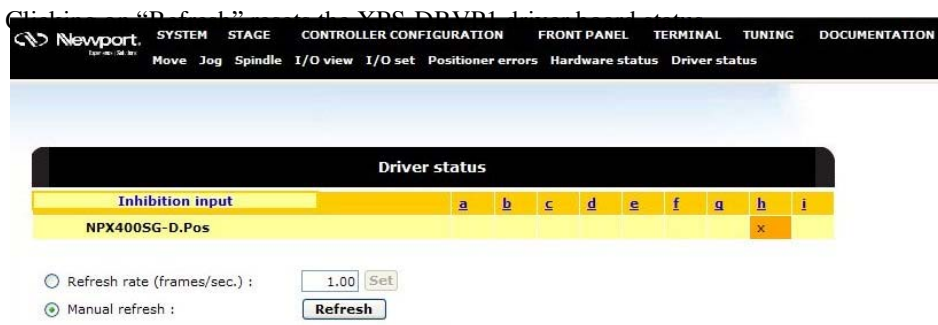

After cancelling the error, the axis must be re-initialize.

This can be done through the XPS Website FRONT PANEL/Move page by clicking on

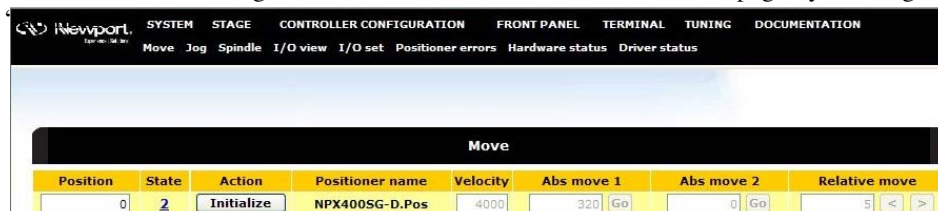

However, if the driver board error hasn't been reset, the XPS will reset it but will also return error (-5).

Move								
Position	State	Action	Positioner name	Velocity	Abs move 1	Abs move 2	Relative move	
0	2	Initialize	NPX400SG-D.Pos	4000	320 Go	0 Go	5 < >	

Error Message : Error -5 : Not allowed due to a positioner error

A second click on "Initialize" is required to complete axis initialization.

Move								
Position	State	Action	Positioner name	Velocity	Abs move 1	Abs move 2	Relative move	
0	42	Home	NPX400SG-D.Pos	4000	320 Go	0 Go	5 < >	

Then a final click on "Home" enables the axis.

Move								
Position	State	Action	Positioner name	Velocity	Abs move 1	Abs move 2	Relative move	
0	11	Disable	NPX400SG-D.Pos	4000	320 Go	0 Go	5 < >	

11.2 Maintenance

The XPS-DRVP1 board requires no particular maintenance. Nevertheless, this is an electronic board that must be kept and handled with precaution.

WARNING

Do not extract the board from the controller until you have read the following, and are at an approved anti-static work station.

Use a conductive wrist strap attached to a good earth ground.

Always turn the controller's power OFF before installing a board.

Always discharge yourself by touching a grounded bare metal surface or approved anti-static mat before picking up an ESD - sensitive electronic component.

Use an approved anti-static mat to cover your work surface.

The XPS-DRVP1 board must be kept in its protective packaging when not in an XPS controller



11.3 Repair

CAUTION

Never attempt to disassemble an element of the driver board.

To disassemble an element can cause a malfunction of the board.



If you observe a malfunction in your board, please contact us immediately to make arrangements for a repair.

CAUTION

Any attempt to disassemble or repair a stage without authorization will void your warranty.



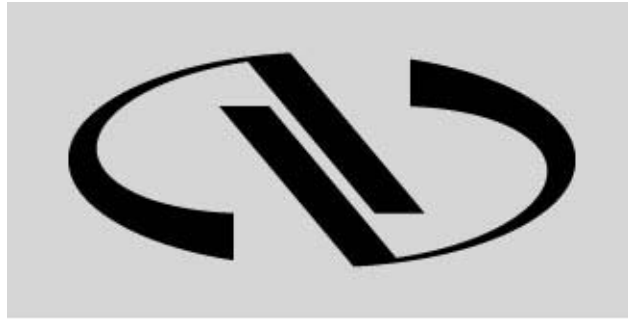

Newport®

Experience | Solutions

Visit Newport Online at:
www.newport.com

North America & Asia

Newport Corporation
1791 Deere Ave.
Irvine, CA 92606, USA

Sales

Tel.: (949) 253-1461
or (800) 222-6440 x31461
e-mail: sales@newport.com

Technical Support

Tel.: (949) 253-1406
or (800) 222-6440 x31406
e-mail: tech@newport.com

Service, RMAs & Returns

Tel.: (949) 253-1694
or (800) 222-6440 x31694
e-mail: rma.service@newport.com

Europe

MICRO-CONTROLE Spectra-Physics S.A.S
1, rue Jules Guesde – Bât. B
ZI Bois de l'Épine – BP189
91006 Evry Cedex
France

Sales

Tel.: +33 (0)1.60.91.68.68
e-mail: france@newport-fr.com

Technical Support

e-mail: tech_europe@newport.com

Service & Returns

Tel.: +33 (0)2.38.40.51.55